

EVF-18X

- Suitable for lighting escape routes and emergency exits
- LED battery monitoring
- For 8W fluorescent tubes

Warning signs

Borosilicate glass

LED battery monitoring



Lamp cover for replacing fluorescent tubes



Compartment for internal batteries

EVF-18...X series Lighting fixtures for safety warnings

EVF-18...X series emergency lamps comply with ATEX Directive 2014/34/UE. They are certified to be installed in Zones 1, 2, 21 and 22. They also fully comply with Directive EN 60598-1 as regards the section on "emergency lamps". These lamps have been specially designed for high performance emergency lighting in areas with little overhead room especially near emergency exits or escape routes. EVF-18...X 8 Watt fluorescent tubes are fitted with electronic ballast. The red/green LED monitors battery function and warns the user in the event of a failure. In the event of a power failure, the system comes on automatically.

Application sectors:



CERTIFICATION DATA

Classification:	Group II	Category 2GD		
Installation: EN 60079.14	zone 1 - zone 2 (Gas)	zona 21 - zona 22 (Dust)		
Marking:	CE 0722 Ex II 2GD Ex d IIC T5 - Ex tD A21 IP 66			
Certification:	ATEX	CESI 03 ATEX 098		
Standards:	CENELEC EN 60079-0: 2006, EN 60079-1: 2007, EN 61241-0: 2006, EN 61241-1: 2004, EN 60598-1:2008+A11:2009, EN 60598-2-1_1989, EN 61547: 2009 and EUROPEAN DIRECTIVE 2014/34/UE IEC 60079-0: 2004, IEC 60079-1: 2007, IEC 61241-0: 2004, IEC 61241-1: 2004 European Directive 2004/108 Electromagnetic compatibility European Directive 2012/19/UE, 2002/96/CE, 2003/108/CE WEEE European Directive 2011/65/UE RoHS			
Class temperature:	100°C (T5)			
Ambient temperature:	-20°C +55°C			
Degree of protection:	IP66			

EVF-18...X series Lighting fixtures for safety warnings

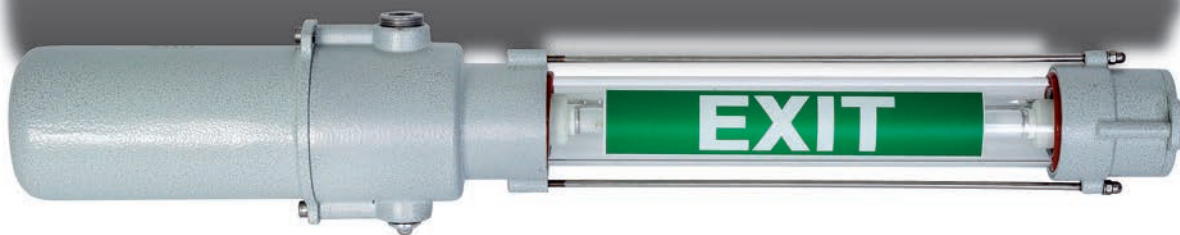

ORIGINAL PRODUCT

MECHANICAL FEATURES

Body:	Low copper content aluminium alloy
External tube:	Shock and high temperature resistant borosilicate glass
Seal:	Silicone resin between the aluminium heads and the glass tubes
Gaskets:	Acid/hydrocarbon resistant NBR
Bolts and screws:	Stainless steel
Mounting:	2 x galvanised steel brackets with Ø9 slots
Entries:	2 x 3/4" threaded NPT. Lighting fixture complete with 1 x PLG2NA aluminium plug
Coating:	Polyester coating Ral 7035 (Light grey)
Corrosion Resistance:	The STANDARD of the aluminium alloy used by Cortem has passed the tests required by standards EN60068-2-30 (hot/humid cycles) and EN60068-2-11 (salt mist tests)

ELECTRICAL FEATURES

Lamp holder:	Bi-pin G5
Ballast:	Electronic
Rated voltage:	230 V AC
Rated frequency:	50/60 Hz
Connection:	Direct to connectors fitted to electronic board L, N, Pe section 0.5 mm ² terminal board with jumpers for input/output
Emergency unit:	Batteries Ni/Cd 2.5 Ah - 6,5 V The LED is used to monitor battery function: the green LED indicates that the lamp is charged and red indicates a faulty battery
Wiring:	Silicone rubber cables with glass braid protection against high temperatures

ACCESSORIES AVAILABLE / SPECIAL REQUESTS

2 pin Ø16 fluorescent tubes model T5
Installation mounting brackets
Cable gland: FGAB2NBK for armoured cable or FB2NBK for non-armoured cable
Warning signs to be requested during ordering
Rated voltage: 120 V (code EVF-18ENX/**120**)
GAS UNI ISO 7/1 thread

EVF-18...X series selection chart

Code	Lamp n°	Operating type	Power supply	Watt	Discharge time of batteries	Weight kg	 mm
EVF-18X	1	normal	230V 50/60Hz	8	-	3,15	1175x120x155
EVF-18EX	1	emergency only	230V 50/60Hz	8	150'	3,40	1175x120x155
EVF-18ENX	1	normal + emergency	230V 50/60Hz	8	150'	3,50	1175x120x155

DIMENSIONAL DRAWINGS

Dimensions in mm

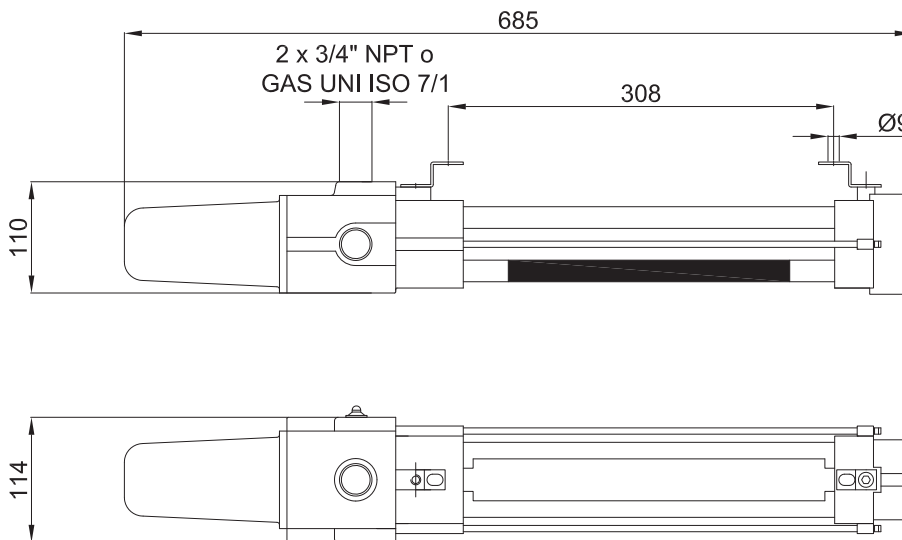

DON'T FORGET TO ORDER THE ACCESSORIES

Example: Type of lighting fixture
EVF-18EX

+ Fluorescent tubes
LAMP-L18W21

+ Installation bracket
G-258

+ Cable gland
FB2NBK

+ other...see key



Standard pictograms to be applied on glass tube

Reference standard: D. LGS. 81 del 09/04/08 V, Directive 92/58/CEE, UNI EN ISO 7010



U-420/SX



U-420/S



















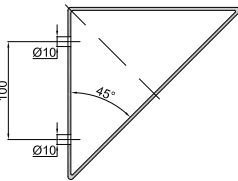

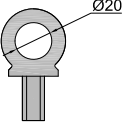

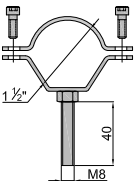





U-420/DX

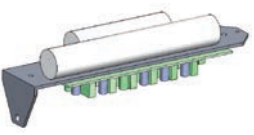

U-420/G

Series EVF-18...X Accessories and spare parts available on request

ILLUSTRATION	DESCRIPTION	MODEL	FEATURES	CODE	KEY
	Triphosphor fluorescent tubes G5 fitting	8 W (FD8W)	430 lm	LAMPL8W21	 
	Standard pictograms to be applied on glass tube		Material: Translucent film	Upon request	 
	Tige	Length: 250 mm	Material: stainless steel	BRF8MIN/250	 
	Type D bracket complete with screws		Material: bracket: galvanised steel screws: stainless steel	G-0611	 
	Type O eyebolt		Material: galvanised steel	GOF-8	 
	Type P bracket		Material: galvanised steel	G-0480	 
	Pressacavo		Per modelli e codici dei pressacavi vedi sito www.cortemgroup.com	FB2NBK FGAB2NBK	 
	External frame for warning sign upon request		For models and codes, visit www.cortemgroup.com	G1-0591	 
	Lamp holder	G5 fitting	230V 4A	G-0448	
	Frame with battery pack and electronic board	EVF-18X	230V 50/60Hz normal operation	G-0452	
		EVF-18EX	230V 50/60Hz emergency only	G-0451	
		EVF-18ENX	230V 50/60Hz normal + emergency	G-0451/1	
	Battery pack	EVF-18EX EVF-18ENX	Ni-Cd 2,5 Ah - 6,5 V	BATT2,5AH/NC	

Installation and mounting methods EVF-18...X series

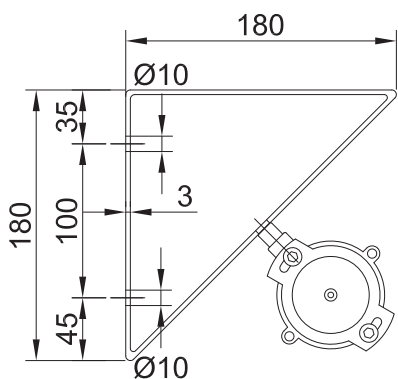

45° angle mounting
TYPE "D"

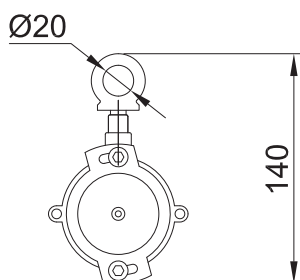

Pendant mounting
with eyebolt TYPE "O"

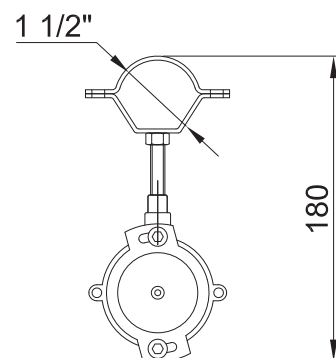

Mounting with
metal clamps 1.1/2" TYPE "P"

Dimensions in mm

Lighting fixture EVF-18EX with accessory G1-0591

